

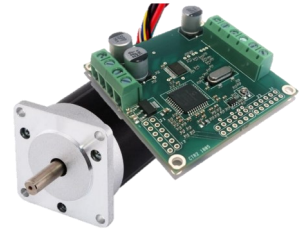

ZDBL30-57470 Sensorless Brushless Motor and Controller.



KEY SPECIFICATIONS



Voltage Range	8-40Vdc
Current	30A max (Continuous current depends on Heatsinking and cooling)
PWM Input	Yes—frequency 1Khz. Can be used for direct speed control or for speed reference with closed loop feedback
Analogue Inputs	0-10Vdc (12bit), 0-3.3V (12bit)
Onboard speed control Potentiometer	Yes
Over current protection	Yes—includes current detection, measurement and limiting.
Over heat protection	Enabled
Reverse Polarity Protection	Fitted
Control Logic Inputs	-0.3 to 3.5Vdc (some 5V compatible inputs available)
Speed range	0-196000 RPM with closed loop feedback. Higher with speed feedback disabled.
Operating ambient temperature	-40~+85C
Conservation temperature	- 40~+1000C
Operating ambient humidity	35~85% RH (no condensation)
Conservation humidity	10~90% RH (no condensation)
Intelligence	Fully programmable enabling key parameters or programmes to be stored
Closed Loop Feedback	Constant Speed or Constant Torque
Open loop feedback	Open loop feedback from Back-EMF
Recommended Motors	Works with Sensorless Brushless DC (optional Back-EMF for constant speed) and can also work with Sensored brushless DC motors using inbuilt sensors for constant speed.
Hard Start	Hard start programme available for applications where starting under load is essential (contact us for more details).
Communications	0-5v analogue input, digital inputs, external hardware, UART, UART over RS232 (UART over RS485 plugin board), CANbus (with plugin board)
Inputs / Outputs (IOs)	5 Protected Digital Inputs, 7 Digital IOs, 1 protected analogue input
RoHS Compliant	Yes
REACH Compliant	Yes

DIMENSIONS

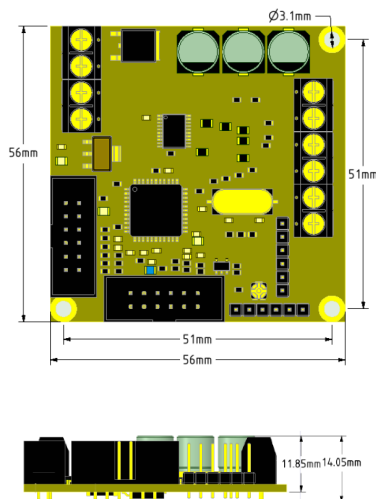

WIRING

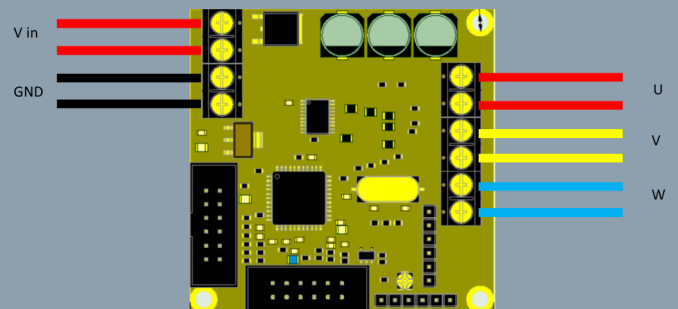

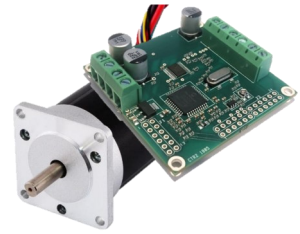

SPECIFICATION

CONNECTIONS

Specification	Rating
Number of Poles	4
Number of Phases	3
Rated Voltage (VDC)	24
Rated Speed (RPM)	3500
Rated Torque (Nm)	0.47
Rated Current (A)	10.4
Rated Power	172w
Shaft Diameter	8
Weight (g)	750
Hall Effect Angle (°)	120

Lead Colour	Function
Red	VCC HALL SENSOR +5 TO 24VDC
Yellow	HALL A
White	HALL B
Blue	HALL C
Black	GND HALL SENSOR
Orange	PHASE U
Green	PHASE V
Brown	PHASE W

RECOMMENDED CONTROLLERS

Controller	Notes
ZDBL30	Sensorless Operation
ZDBL20DC	Full control, including 4 quadrant operation.
ZDBL20DC-E	Standard sensored operation.

DIMENSIONS

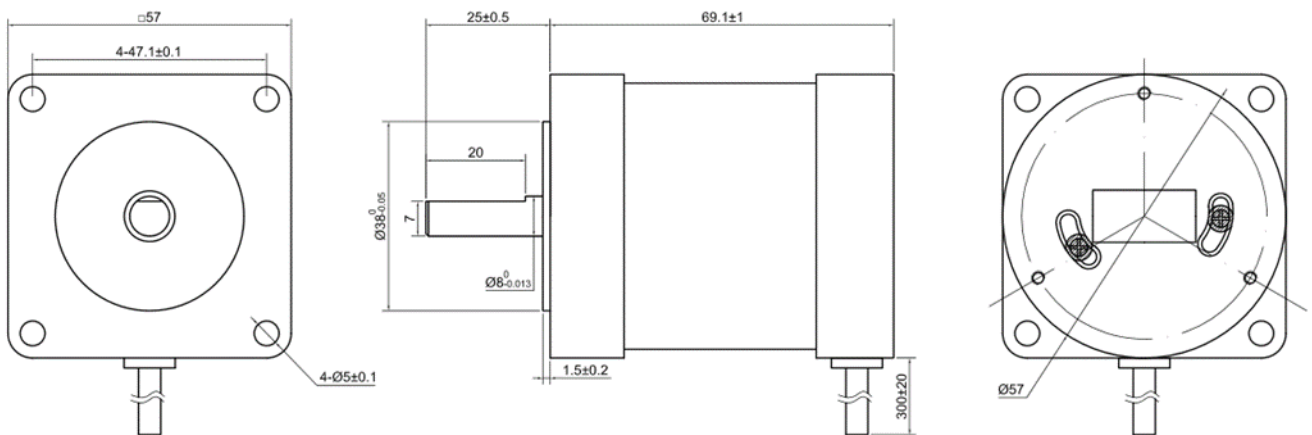



ZDBL30-57470 Sensorloser bürstenloser Motor und Con- troller

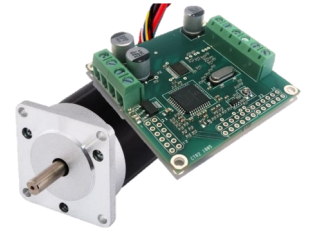

KEY SPECIFICATIONS



Spannungsbereich	8-40Vdc
Strom	30A max (Dauerstrom hängt von Kühlung und Kühlung ab)
PWM Eingang	Ja-Frequenz 1 kHz. Kann für direkte Drehzahlregelung oder Drehzahlreferenz mit geschlossenem Regelkreis verwendet werden
Analogeingänge	0-10Vdc (12bit), 0-3.3V (12bit)
Onboard Geschwindigkeitsregelung Potentiometer	Ja
Überstromschutz	Ja—umfasst strom Erkennung, Messung und Begrenzung.
Überhitzungsschutz	Aktiviert
Verpolungsschutz	Tailliert
Steuerungslogikeingänge	-0.3 to 3.5Vdc (einige 5V kompatible Eingänge verfügbar)
Geschwindigkeitsbereich	0-196000 U / min mit geschlossener Rückkopplung. Höher, wenn die Geschwindigkeitsrückmeldung deaktiviert ist.
Betriebsumgebungstemperatur	-40~+85°C
Konservierungstemperatur	- 40~+1000°C
Betriebsumgebungsfeuchtigkeit	35~85% RH (keine Kondensation)
Erhaltung Feuchtigkeit	10~90% RH (keine Kondensation)
Intelligenz	Vollständig programmierbare Freigabe-Schlüsselparameter oder -programme werden gespeichert
Closed loop feedback	Konstante Geschwindigkeit oder konstantes Drehmoment
Open loop feedback	Open-Loop-Feedback von Back-EMF
Empfohlene Motoren	Arbeitet mit sensorloser bürstenloser DC (optionales Back-EMF für konstante Geschwindigkeit) und kann auch mit bürstenlosen Gleichstrommotoren von Sensored mit eingebauten Sensoren für konstante Geschwindigkeit arbeiten.
Schwerer Start	Hard-Start-Programm für Anwendungen, bei denen das Starten unter Last erforderlich ist (Kontaktieren Sie uns für weitere Details)
Kommunikationen	0-5V Analogeingang, Digitaleingänge, externe Hardware, UART, UART über RS232 (UART über RS485-Steckkarte), CANbus (mit Steckkarte)
Eingänge/ Ausgänge(I/Os)	5 geschützte digitale Eingänge, 7 digitale IOs, 1 geschützter analoger Eingang
RoHS Konform	Ja
REACH Konform	Ja

MASSE

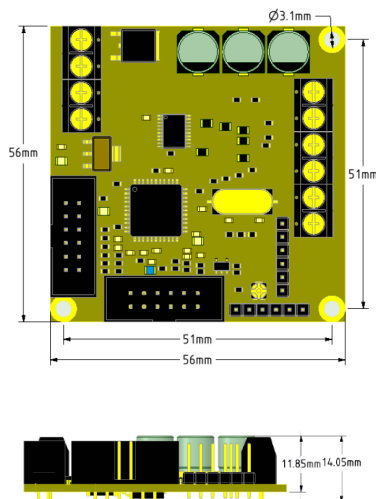

VERDRAHTUNG

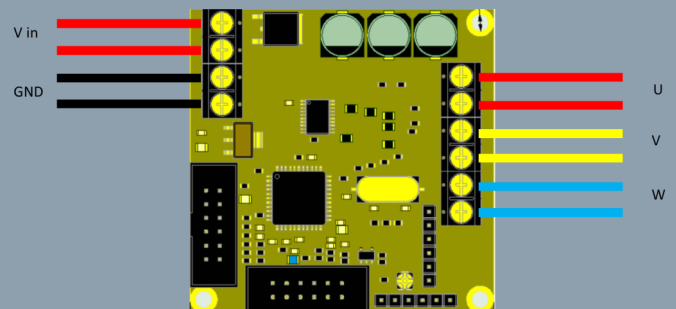



ZDBL30-57470 Moteur sans balai sans capteur et contrôleur .

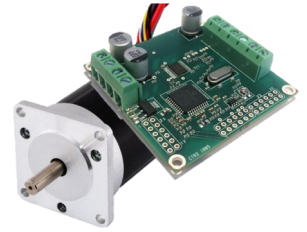

KEY SPECIFICATIONS

Plage de tension	8-40Vdc
Courant	30A max (Le courant continu dépend du radiateur et du refroidissement)
Entrée PWM	Oui-fréquence 1Khz. Peut être utilisé pour le contrôle direct de la vitesse ou pour la référence de vitesse avec un retour en boucle fermée
Entrées analogiques	0-10Vdc (12bit), 0-3.3V (12bit)
Potentiomètre de contrôle de la vitesse à bord	Oui
Protection contre les surintensités	Oui—comprend la détection de courant, la mesure et la limitation.
Protection contre la surchauffe	Activée
Protection contre la polarité inversée	Ajusté
Entrées logiques de contrôle	-0.3 to 3.5Vdc (quelques entrées compatibles 5V disponibles)
Plage de vitesse	0-196000 RPM avec retour en boucle fermée. Plus haut avec retour de vitesse désactivé.
Température ambiante de fonctionnement	-40~+85°C
Température de conservation	- 40~+1000°C
Humidité ambiante en fonctionnement	35~85% RH (pas de condensation)
Humidité de conservation	10~90% RH (pas de condensation)
Intelligence	Entièrement programmable permettant d'enregistrer les paramètres ou les programmes clés
Commentaires en boucle fermée	Vitesse constante ou couple constant
Retour en boucle ouverte	Retour en boucle ouverte de Back-EMF
Moteurs recommandés	Fonctionne avec le DC sans balai sans capteur (option EMF arrière pour une vitesse constante) et peut également fonctionner avec des moteurs à courant continu sans balais sensibles avec des capteurs intégrés pour une vitesse constante.
Démarrage difficile	Programme de démarrage difficile disponible pour les applications où le démarrage sous charge est essentiel (contactez-nous pour plus de détails).
Communications	Entrée analogique 0-5v, entrées numériques, matériel externe, UART, UART sur RS232 (UART sur RS485), CANbus (avec carte d'extension)
Entrée/ sortie(IOs)	5 entrées numériques protégées, 7 entrées / sorties numériques, 1 entrée analogique protégée
RoHS Conforme	Oui
REACH Conforme	Oui

DIMENSIONS

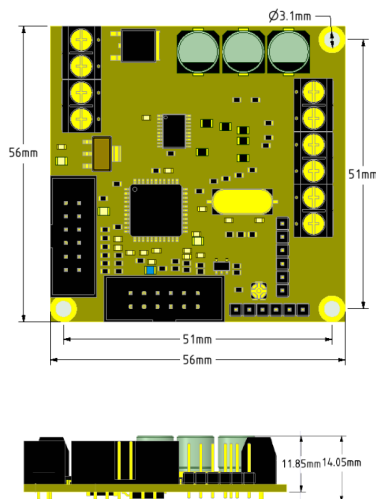

CÂBLAGE

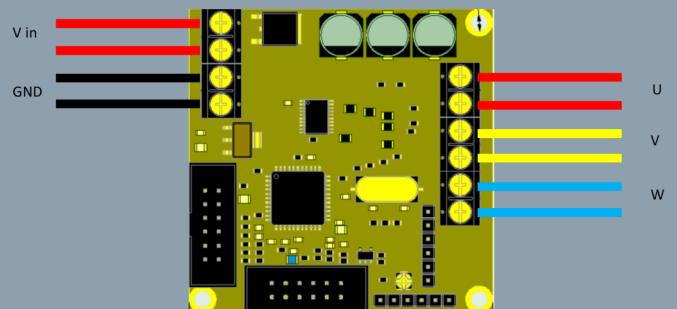

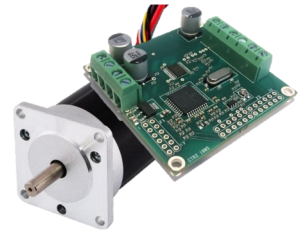

SPÉCIFICATION

LES LIAISONS

Spécification	Évaluation
Nombre de pôles	4
Nombre de phases	3
Tension nominale (VDC)	24
Vitesse évaluée (RPM)	3500
Couple nominal (Nm)	0.47
Courant nominal (A)	10.4
Puissance nominale (W)	172w
Diamètre de l'arbre (mm)	8
Poids (g)	750
Angle d'effet Hall (°)	120

Couleur de plomb	Fonction
Rouge	VCC HALL SENSOR +5 TO 24VDC
Jaune	HALL A
Blanc	HALL B
Bleu	HALL C
Noir	GND HALL SENSOR
Orange	PHASE U
Vert	PHASE V
Marron	PHASE W

CONTRÔLEURS RECOMMANDÉS

Manette	Remarques
ZDBL30	Fonctionnement sans capteur
ZDBL20DC	Contrôle total, y compris le fonctionnement à 4 quadrants.
ZDBL20DC-E	Opération sensorielle standard.

DIMENSIONS

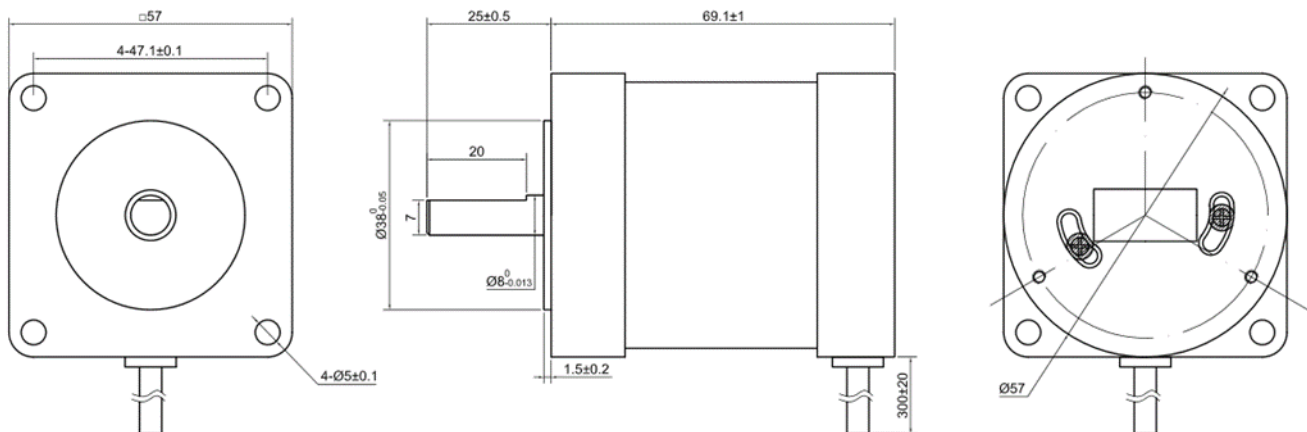



ZDBL30-57470 Motor sin escobillas sin sensor y controlador

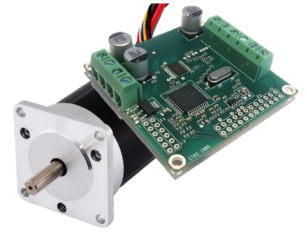

KEY SPECIFICATIONS



Rango de voltaje	8-40Vdc
Corriente	30A max (La corriente continua depende del disolvente y de la refrigeración)
Entrada PWM	Sí-frecuencia 1Khz. Se puede utilizar para el control directo de la velocidad o para la referencia de la velocidad con la regeneración del lazo cerrado
Entradas Analógicas	0-10Vdc (12bit), 0-3.3V (12bit)
Control de velocidad a bordo Potenciómetro	Sí
Protección contra la sobretensión	Sí—incluye detección de corriente, medición y limitación.
Protección contra el sobrecalentamiento	Habilitado
Protección de Polaridad Inversa	Montado
Entradas lógicas de control	-0.3 to 3.5Vdc (algunas entradas compatibles de 5V disponibles)
Rango de velocidad	0-196000 RPM con realimentación en circuito cerrado. Mayor con retroalimentación de velocidad desactivada.
Temperatura ambiente de funcionamiento	-40~+85°C
Temperatura de conservación	- 40~+1000°C
Humedad ambiente de funcionamiento	35~85% RH (sin condensación)
Humedad de conservación	10~90% RH (sin condensación)
Inteligencia	Totalmente programable permitiendo que los parámetros o programas clave sean almacenados
Comentarios del circuito cerrado	Velocidad constante o par constante
Retroalimentación en bucle abierto	Retroalimentación en bucle abierto de Back-EMF
Motores recomendados	Funciona con Sensorless Brushless DC (opcional Back-EMF para velocidad constante) y también puede trabajar con sensored brushless DC motores utilizando sensores incorporados para una velocidad constante.
Duro comienzo	Programa de arranque duro disponible para aplicaciones en las que es indispensable arrancar bajo carga (póngase en contacto con nosotros para más detalles).
Comunicaciones	Entrada analógica de 0-5v, entradas digitales, hardware externo, UART, UART sobre RS232 (UART sobre placa de complemento RS485), CANbus (con placa de complemento)
Salidas/ entradas (IOs)	5 entradas digitales protegidas, 7 IO digitales, 1 entrada analógica protegida
RoHS Obediente	Sí
REACH Obediente	Sí

DIMENSIONES

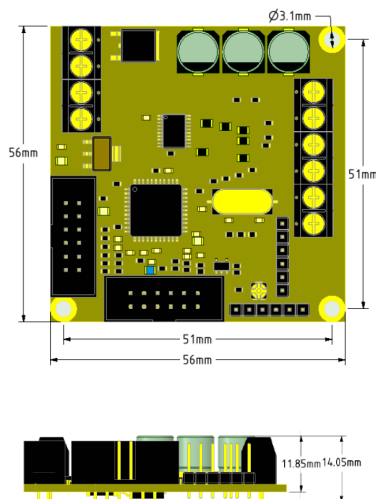

ALAMBRADO

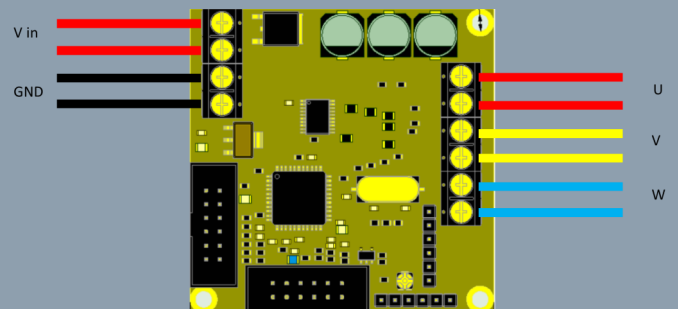

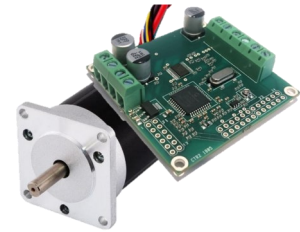

ESPECIFICACIÓN

CONEXIONES

Especificación	Clasificación
Número de polos	4
Numero de fases	3
Voltaje nominal (VDC)	24
Velocidad nominal (RPM)	3500
Par nominal (Nm)	0.47
Corriente clasificada (A)	10.4
Energía clasificada (W)	172w
Diámetro del eje (mm)	8
Peso (g)	750
Ángulo de efecto Hall (°)	120

Color de plomo	Función
Rojo	VCC HALL SENSOR +5 TO 24VDC
Amarillo	HALL A
Blanco	HALL B
Azul	HALL C
Negro	GND HALL SENSOR
Naranja	PHASE U
Verde	PHASE V
Marron	PHASE W

CONTROLADORES RECOMENDADOS

Controlador	Notas
ZDBL30	Operación sin sensor
ZDBL20DC	Control total, incluida la operación de 4 cuadrantes.
ZDBL20DC-E	Operación sensorada estándar

DIMENSIONES

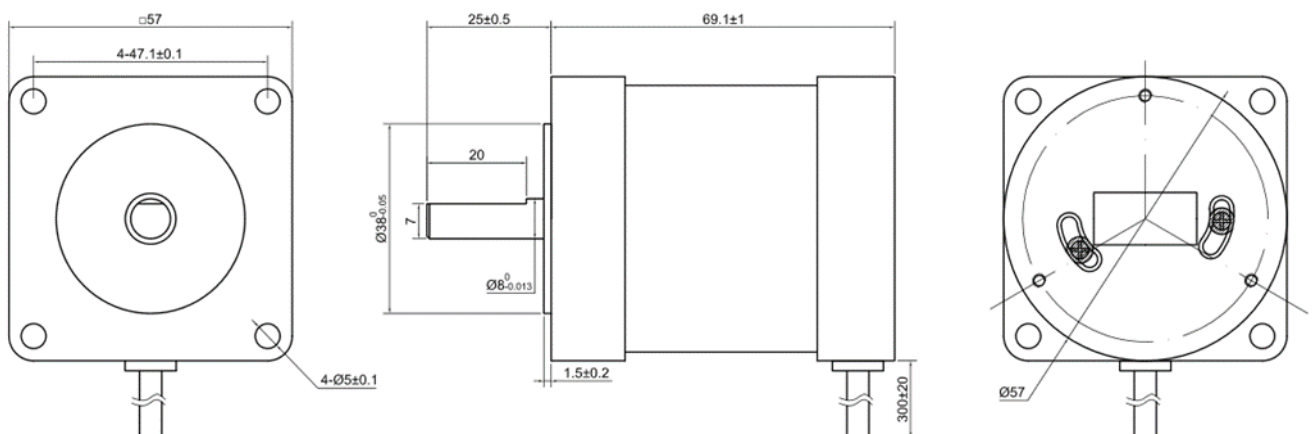



ZDBL30-57470 Motore brushless sensorless e controller

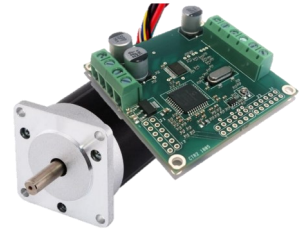

KEY SPECIFICATIONS

Gamma di tensione	8-40Vdc
Corrente	30A max (La corrente continua dipende dal dissipatore di calore e dal raffreddamento)
Ingresso PWM	Si-frequenza 1Khz. Può essere utilizzato per il controllo diretto della velocità o per il riferimento di velocità con feedback a circuito chiuso.
Ingressi analogici	0-10Vdc (12bit), 0-3.3V (12bit)
Potenzimetro a bordo di velocità	sì
Oltre protezione corrente	sì—include la rilevazione, la misurazione e la limitazione della corrente.
Sopra la protezione termica	Abilitato
Protezione polarità inversa	attrezzato
Ingressi logici di controllo	-0.3 to 3.5Vdc (alcuni ingressi compatibili 5V disponibili)
Velocità di velocità	0-196000 RPM con feedback a circuito chiuso. Maggiore con la velocità di feedback disabilitata.
Temperatura ambiente di funzionamento	-40~+85°C
Temperatura di conservazione	- 40~+1000°C
Umidità di funzionamento dell'ambiente	35~85% RH (senza condensa)
Umidità di conservazione	10~90% RH (senza condensa)
Intelligenza	Programmabili per memorizzare i parametri oi programmi chiave
Risposte a ciclo chiuso	Velocità costante o coppia costante
Feedback aperto del loop	Feedback aperto del loop da Back-EMF
Motori consigliati	Funziona con DC senza spazzola senza sensore (Back-EMF opzionale per velocità costante) e può anche lavorare con motori a corrente continua senza sensori con sensori integrati per la velocità costante.
Inizio duro	Programma di avvio duro disponibile per applicazioni in cui è necessario avviare il carico sotto carico (contattateci per ulteriori informazioni).
Comunicazioni	Ingresso analogico 0-5v, ingressi digitali, hardware esterno, UART, UART su RS232 (scheda UART over RS485), CANbus (con scheda plugin)
Entrate/ Uscite (IOs)	5 ingressi digitali protetti, 7 IO digitali, 1 ingresso analogico protetto
RoHS Conforme	sì
REACH Conforme	sì

DIMENSIONI

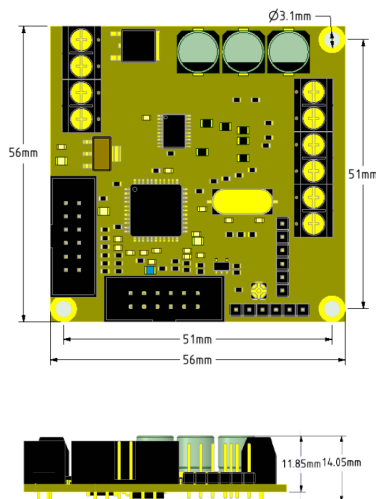

CABLAGGIO

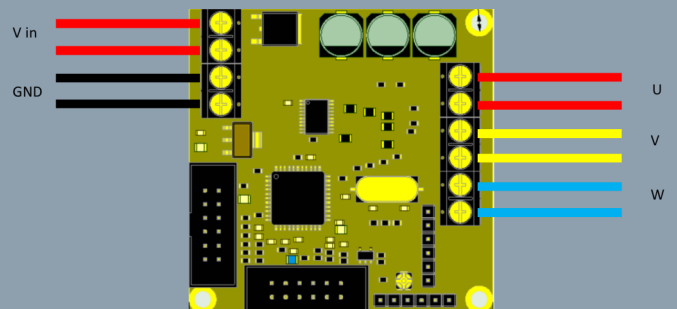

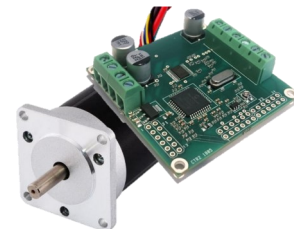

SPECIFICHE

COLLEGAMENTI

Specificazione	Valutazione
Numero di poli	4
Numero di fasi	3
Tensione nominale (VDC)	24
Velocità nominale (RPM)	3500
Coppia nominale (Nm)	0.47
Corrente nominale (A)	10.4
Potenza nominale (W)	172w
Diametro albero (mm)	8
Peso (g)	750
Angolo dell'effetto Hall (°)	120

Colore di piombo	Funzione
Rosso	VCC HALL SENSOR +5 TO 24VDC
Giallo	HALL A
Blanca	HALL B
Blu	HALL C
Nero	GND HALL SENSOR
Arancia	PHASE U
Verde	PHASE V
Marrone	PHASE W

CONTROLLORI RACCOMANDATI

Controllore	Gli appunti
ZDBL30	Funzionamento senza sensori
ZDBL20DC	Controllo completo, incluso il funzionamento a 4 quadranti.
ZDBL20DC-E	Funzionamento sensoriale

DIMENSIONI

