

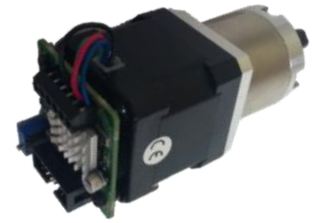



ZDSPN17G51-4—Geared NEMA 17 Stepper Motor with 2A programmable stepper motor controller



KEY SPECIFICATIONS 	
Voltage Range	11-30Vdc
Current	0-2A adjustable
Microstep Resolution	Full step, Half Step, Quarter Step or 1/16 step
Pulse Input	Optional
0-5Vdc input	10bit Available
Onboard speed control Potentiometer	23 Turn (10 bit)
Over current protection	Enabled
Over heat protection	Enabled
Reverse Polarity Protection	Fitted
Control Logic Inputs	-0.3 to 6Vdc
Max RPM	Typically 1000rpm depending on motor and operating voltage (Contact us for more details)
Operating ambient temperature	0~+50C
Conservation temperature	- 20~+70C
Operating ambient humidity	35~85% RH (no condensation)
Conservation humidity	10~90% RH (no condensation)
Speed Resolution	24 bit speed resolution enables exceptionally fine speed accuracy (16777215 total speeds available).
Encoder Feedback	Yes
Closed loop feedback	Yes
Intelligence	ZDSP is fully programmable, enabling it to store key parameters or run specific programmes on signal input (contact us for more details)
Communication	0-5v analogue input, digital inputs, external hardware, UART, UART over RS232 (UART over RS485 plugin board)
Inputs / Outputs (IOs)	5 Digital IOs, 1 Analogue (unprotected genuine IO)
RoHS Compliant	Yes
REACH Compliant	Yes

DIMENSIONS

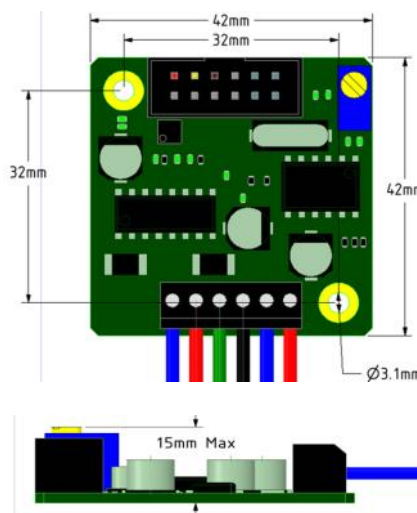

WIRING

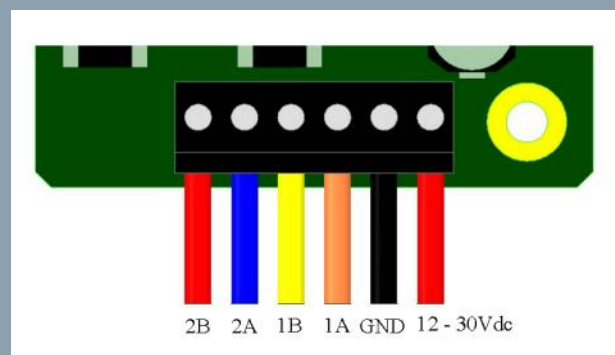



KEY SPECIFICATIONS



Weight (kg)	0.60	Max Permissible Torque (Nm)	4
Backlash at no load (°)	<=1	Momentary Permissible Torque (Nm)	6
Step Accuracy	+/-5.00%	Exact Gearbox Ratio	50.876:1
Step Angle without gearbox (°)	1.80		
Efficiency	73%		
Phase Inductance (mH)	2.8		
Phase Current (A)	1.68		
Phase Voltage (VDC)	2.8		
Phase Resistance (Ohms)	1.65		

DIMENSIONS

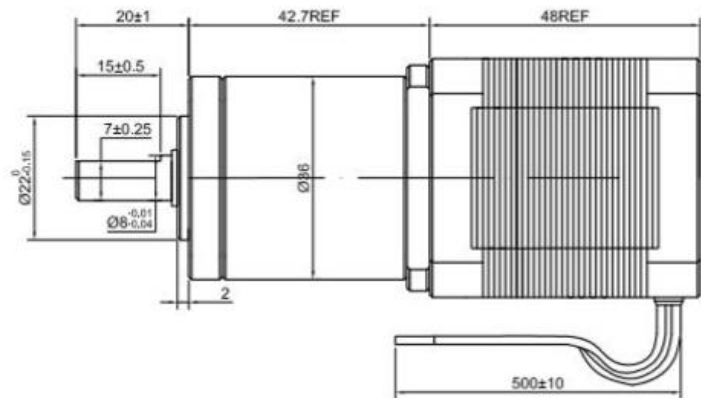
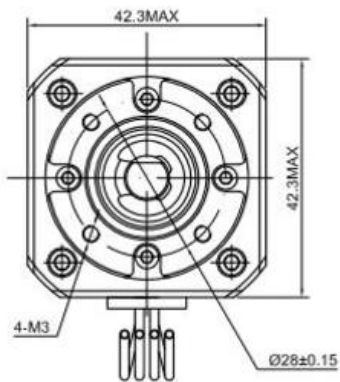

WIRING

CONNECTION		MOTOR
Pin Number	Bipolar	Leads
1	A	Black
2	A\	Green
3	B	Red
4	B\	Blue

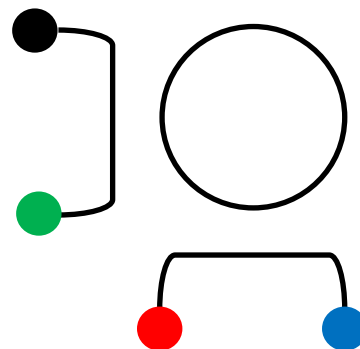



ZDSPN17G51-4-Geared NEMA 17

Schrittmotor mit 2A programmierbaren Schrittmotor-Controller

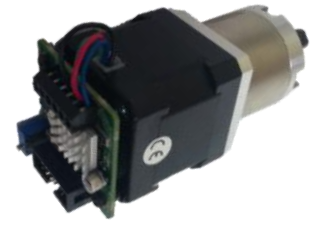

KEY SPECIFICATIONS	
Spannungsbereich	11-30Vdc
Strom	0-2A einstellbar
Microstep Auflösung	Vollschritt, Halbschritt, Viertelschritt oder 1/16 Schritt
Impulseingang	Optional
0-5Vdc Analogeingang	10bit einstellbar
Onboard Geschwindigkeitsregelung Potentiometer	23 Turn (10 bit)
Überstromschutz	Aktiviert
Überhitzungsschutz	Aktiviert
Verpolungsschutz	Tailliert
Steuerungslogikeingänge	-0.3 to 6Vdc
Max RPM	Typischerweise 1000 U / min in Abhängigkeit von Motor und Betriebsspannung (Kontaktieren Sie uns für weitere details)
Betriebsumgebungstemperatur	0~+50C
Konservierungstemperatur	- 20~+70C
Betriebsumgebungsfeuchtigkeit	35~85% RH (keine Kondensation)
Erhaltung Feuchtigkeit	10~90% RH (keine Kondensation)
Geschwindigkeitsauflösung	Die 24-Bit-Geschwindigkeitsauflösung ermöglicht eine außergewöhnlich hohe Geschwindigkeitsgenauigkeit (16777215 verfügbare Gesamtgeschwindigkeiten).
Encoder-Feedback	Ja
Closed -loop- feedback	Ja
Intelligenz	ZDSP ist vollständig programmierbar und ermöglicht die Speicherung von Schlüsselparametern oder die Ausführung bestimmter Programme am Signaleingang Kontaktieren Sie uns für weitere details)
Kommunikation	0-5V Analogeingang, digitale Eingänge, externe Hardware, UART, UART über RS232 (UART über RS485-Steckkarte)
Eingänge/ Ausgänge (IOs)	5 digitale IOs, 1 analog (ungeschütztes echtes IO)
RoHS Konform	Ja
REACH Konform	Ja

MASSE

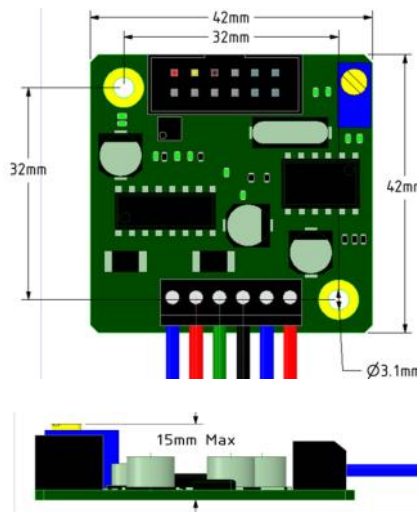

VERDRAHTUNG

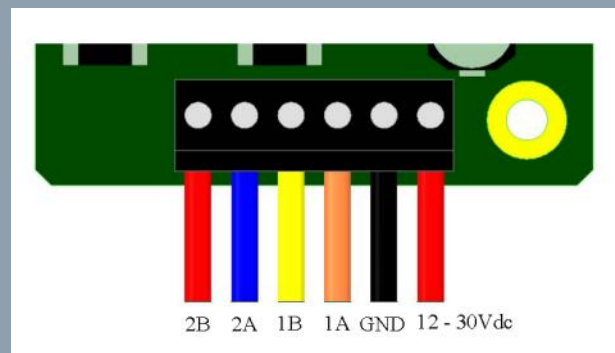

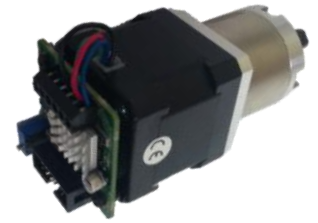

Schlüsselspezifikationen

Gewicht (kg)	0.60	Max. Zulässiges Drehmoment(Nm)	4
Spiel im Leerlauf(°)	<=1	Momentan zulässiges Drehmoment (Nm)	6
Schritt Genauigkeit	+/-5.00%	Genaues Getriebeverhältnis	50.876:1
Schrittwinkel ohne Getriebe(°)	1.80		
Effizienz	73%		
Phaseninduktivität (mH)	2.8		
Phasenstrom (A)	1.68		
Phasenspannung (VDC)	2.8		
Phasenwiderstand(Ohms)	1.65		

Masse

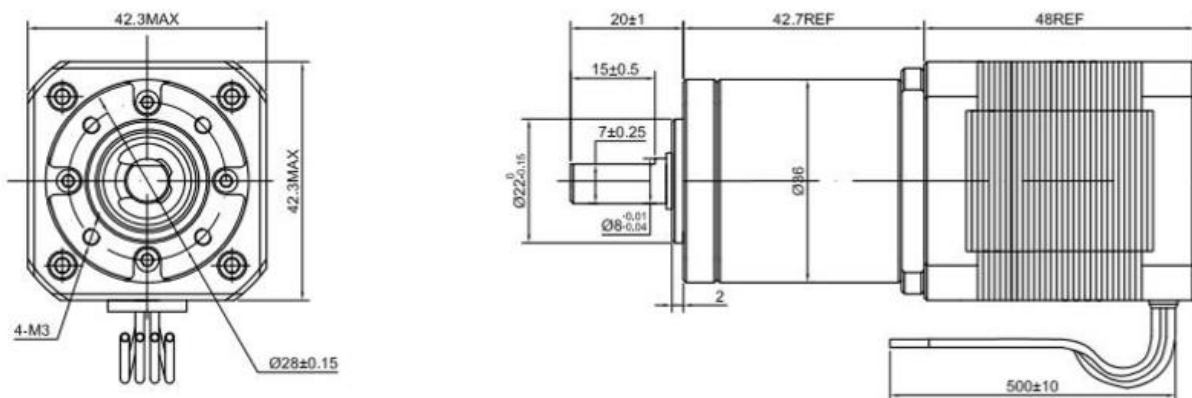

Verdrahtung

VERBINDUNG		MOTOR
Anzahl der stifte	Bipolar	Leitung
1	A	Schwarz
2	A\	Grün
3	B	Rot
4	B\	Blau

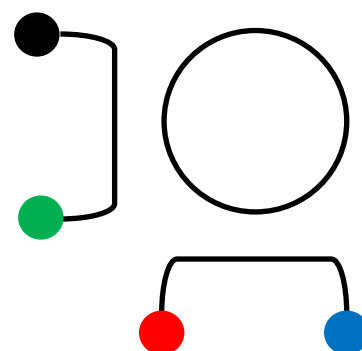



ZDSPN17G51-4 Moteur pas à pas NEMA 17 à engrenage avec contrôleur de moteur pas à pas



KEY SPECIFICATIONS

Plage de tension	11-30Vdc
Courant	0-2A ajustable
Résolution Microstep	Étape complète, Demi-pas, Demi-pas ou 1/16 de pas
Entrée d'impulsions	optionnel
Entrée 0-5Vdc	10bit disponible
Potentiomètre de contrôle de la vitesse à bord	23 Turn (10 bit)
Protection contre les surintensités	Activée
Protection contre la surchauffe	Activée
Protection contre la polarité inversée	Ajusté
Entrées logiques de contrôle	-0.3 to 6Vdc
Max RPM	Typiquement 1000rpm selon le moteur et la tension de fonctionnement (Contactez-nous pour plus de détails)
Température ambiante de fonctionnement	0~+50C
Température de conservation	- 20~+70C
Humidité ambiante en fonctionnement	35~85% RH (pas de condensation)
Humidité de conservation	10~90% RH (pas de condensation)
Résolution rapide	La résolution de vitesse 24 bits permet une précision de vitesse exceptionnellement fine (16777215 vitesses totales disponibles).
Rétroaction du codeur	Oui
Commentaires en boucle fermée	Oui
Intelligence	ZDSP est entièrement programmable, ce qui lui permet de stocker des paramètres clés ou d'exécuter des programmes spécifiques sur l'entrée du signal (nous contacter pour plus de détails)
la communication	Entrée analogique 0-5v, entrées numériques, matériel externe, UART, UART sur RS232 (carte UART sur RS485)
Entrée/ sortie (IOs)	5 IO numériques, 1 Analogique (IO véritable non protégé)
RoHS Conforme	Oui
REACH Conforme	Oui

DIMENSIONS

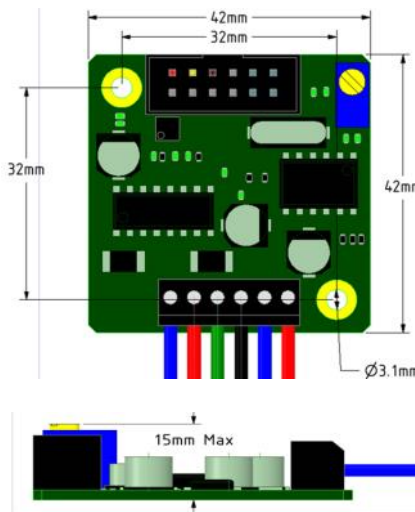

CÂBLAGE

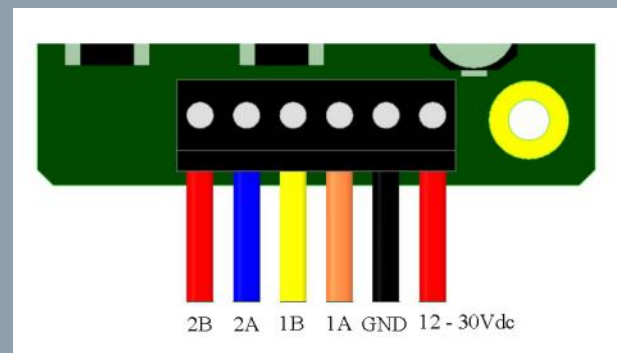



SPÉCIFICATIONS CLÉS

Poids (kg)	0.60	Couple maximal autorisé (Nm)	4
Secousse sans charge (°)	<=1	Momentary Couple admissible(Nm)	6
Précision de l'étape	+/-5.00%	Rapport de boîte de vitesses exact	50.876:1
Step Angle sans boîte de vitesses(°)	1.80		
Efficacité	73%		
Inductance de phase (mH)	2.8		
Phase courant(A)	1.68		
Phase Tension(VDC)	2.8		
Résistance de phase (Ohms)	1.65		

DIMENSIONS

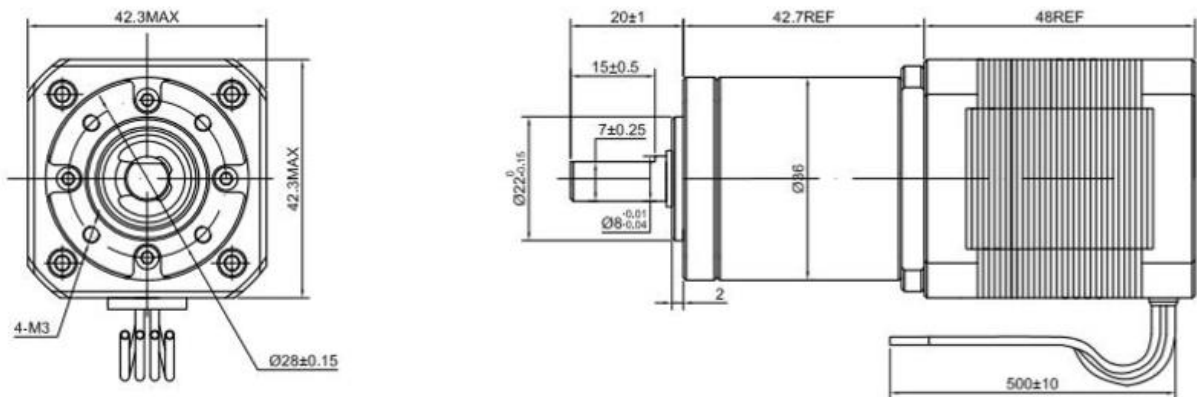

CÂBLAGE

CONNEXION		MOTEUR
Nombre de épingle	Bipolaire	Plombures
1	A	Black
2	A\	Green
3	B	Red
4	B\	Blue

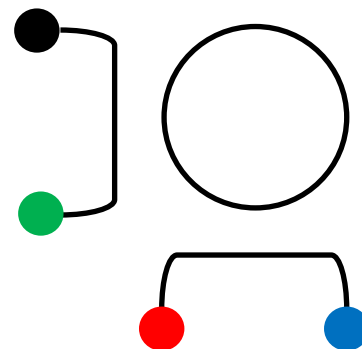



Motor paso a paso NEMA 17 con engranaje ZDSPN17G51-4 con controlador de motor

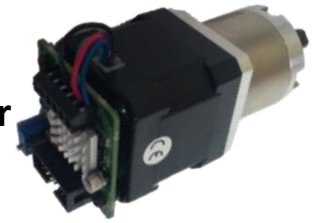

KEY SPECIFICATIONS



Rango de voltaje	11-30Vdc
Corriente	0-2A ajustable
Resolución Microstep	Paso completo, paso medio, paso cuarto o paso 1/16
Entrada de pulso	Opcional
0-5Vdc entrada	10bit Disponible
Control de velocidad a bordo Potenciómetro	23 Turn (10 bit)
Protección contra la sobretensión	Habilitado
Protección contra el sobrecalentamiento	Habilitado
Protección de Polaridad Inversa	Montado
Entradas lógicas de control	-0.3 to 6Vdc
RPM máximo	Típicamente 1000rpm dependiendo del motor y del voltaje de funcionamiento (nos entra en contacto con para más detalles)
Temperatura ambiente de funcionamiento	0~+50C
Temperatura de conservación	- 20~+70C
Humedad ambiente de funcionamiento	35~85% RH (sin condensación)
Humedad de conservación	10~90% RH (sin condensación)
Resolución de velocidad	La resolución de velocidad de 24 bits permite una precisión de velocidad excepcionalmente fina (16777215 velocidades totales disponibles).
Comentarios del codificador	Sí
Retroalimentación en bucle cerrado	Sí
Inteligencia	ZDSP es completamente programable, permitiéndole almacenar los parámetros dominantes o ejecutar programas específicos en la entrada de la señal (nos entra en contacto con para más detalles)
Comunicación	Entrada analógica 0-5v, entradas digitales, hardware externo, UART, UART sobre RS232 (UART sobre tarjeta de plugin RS485)
Salidas, entradas (IOs)	5 E / S digitales, 1 Analógico (IO no protegido)
RoHS Obediente	Sí
DIMENSIONES	Sí
ALAMBRADO	

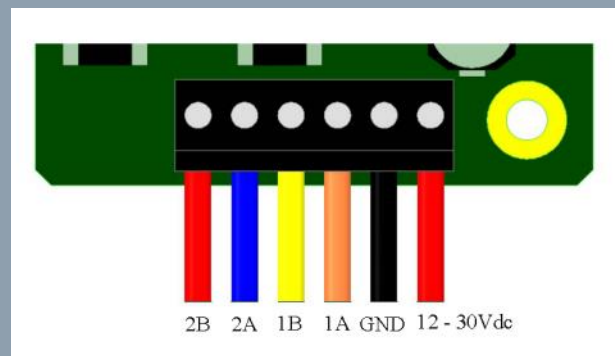
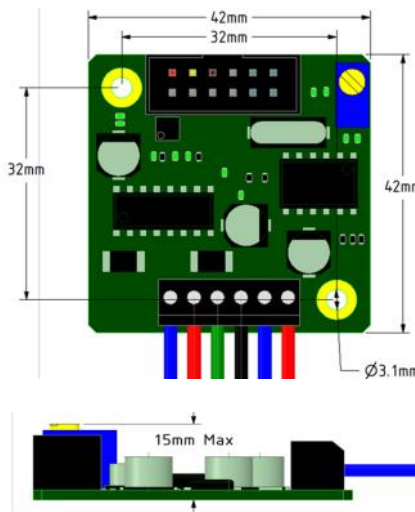

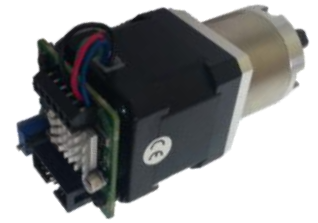

ESPECIFICACIONES			
Peso (kg)	0.60	Par permitido máximo (Nm)	4
Contragolpe sin carga (°)	<=1	Par momentáneo permisible(Nm)	6
Exactitud del paso	+/-5.00%	Proporción exacta de caja de engranes	50.876:1
Ángulo de paso sin caja de cambios (°)	1.80		
Eficiencia	73%		
Inductancia de fase (mH)	2.8		
Fase corriente (A)	1.65		
Voltaje de fase (VDC)	2.8		
Resistencia de fase (Ohms)	1.68		

DIMENSIONES

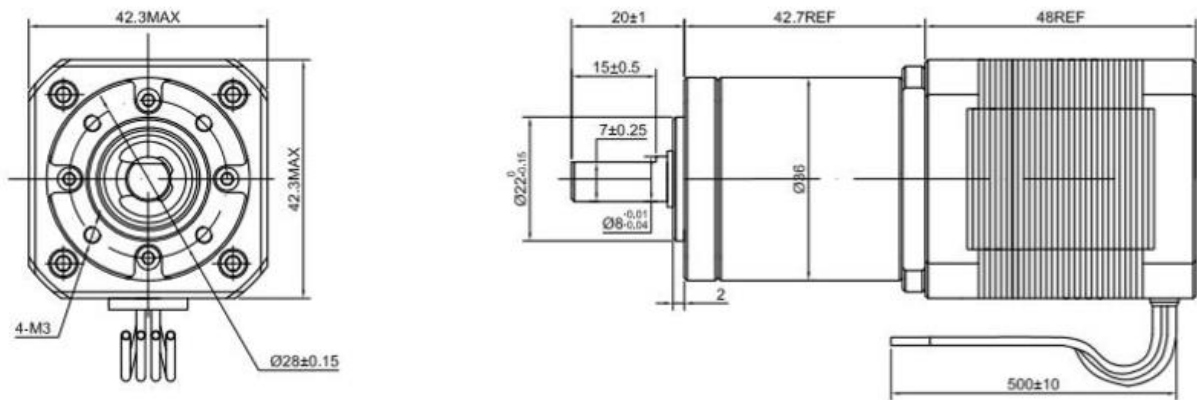

ALAMBRADO

CONEXIÓN		MOTOR
Número de pines	Bipolar	Cable
1	A	Negro
2	A\	Verde
3	B	Rojo
4	B\	Azul

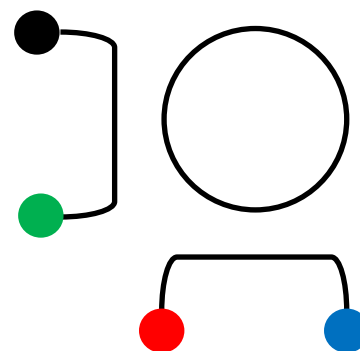



Motore passo-passo NEMA 17 con riduttore ZDSPN17G51-4 con controller motore passo-passo

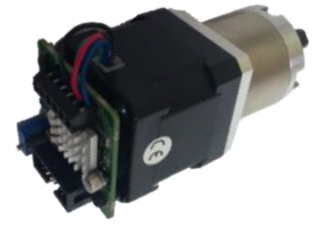

KEY SPECIFICATIONS	
Gamma di tensione	11-30Vdc
Corrente	0-2A regolabile
Risoluzione Microstep	Passo completo, Passo intermedio, Passo trimestre o passo 1/16
Impulso	Opzionale
Ingresso 0-5Vdc	10bit A disposizione
Potenziometro a bordo di velocità	23 Turn (10 bit)
Oltre protezione corrente	Abilitato
Sopra la protezione termica	Abilitato
Protezione polarità inversa	attrezzato
Ingressi logici di controllo	-0.3 to 6Vdc
Max RPM	Tipicamente 1000 rpm a seconda della tensione motore e di funzionamento (contattateci per maggiori dettagli)
Temperatura ambiente di funzionamento	0~+50C
Temperatura di conservazione	- 20~+70C
Umidità di funzionamento dell'ambiente	35~85% RH (senza condensa)
Umidità di conservazione	10~90% RH (senza condensa)
Risoluzione di velocità	La risoluzione a 24 bit consente la precisione di velocità eccezionalmente fine (16777215 velocità totali disponibili).
Encoder Feedback	sì
Feedback sul Loop Chiuso	sì
Intelligenza	ZDSP è completamente programmabile, consentendo di memorizzare i parametri chiave o eseguire programmi specifici sull'ingresso del segnale (contattateci per maggiori dettagli)
Comunicazione	Ingresso analogico 0-5v, ingressi digitali, hardware esterno, UART, UART su RS232 (scheda UART over RS485 plugin)
Entrate Uscite (IOs)	5 IO digitali, 1 analogico (IO genuino non protetto)
RoHS Conforme	sì
REACH Conforme	sì

DIMENSIONI

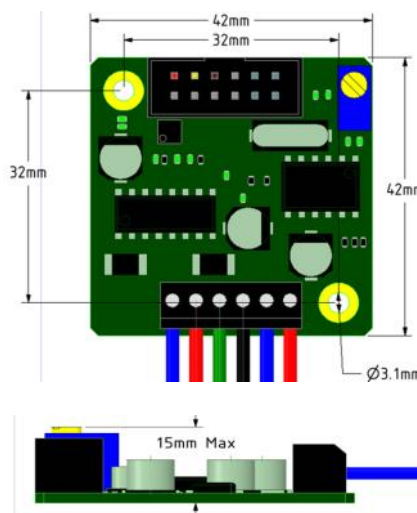

CABLAGGIO

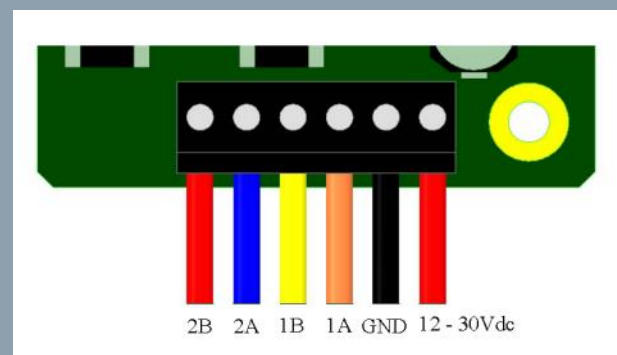

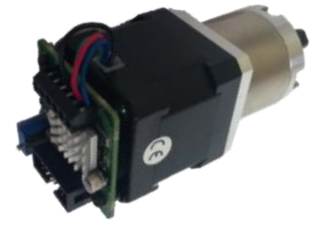

SPECIFICHE CHIAVE

Peso (kg)	0.60	Coppia massima consentita (Nm)	4
Backlash a vuoto (°)	<=1	Coppia momentanea ammissibile(Nm)	6
Accuratezza del passo	+/-5.00%	Rapporto di trasmissione esatto	50.876:1
Step Angle senza riduttore (°)	1.80		
Efficienza	73%		
Induttanza di fase (mH)	2.8		
Corrente di fase (A)	1.68		
Tensione di fase (VDC)	2.8		
Resistenza di fase (Ohms)	1.65		

DIMENSIONI

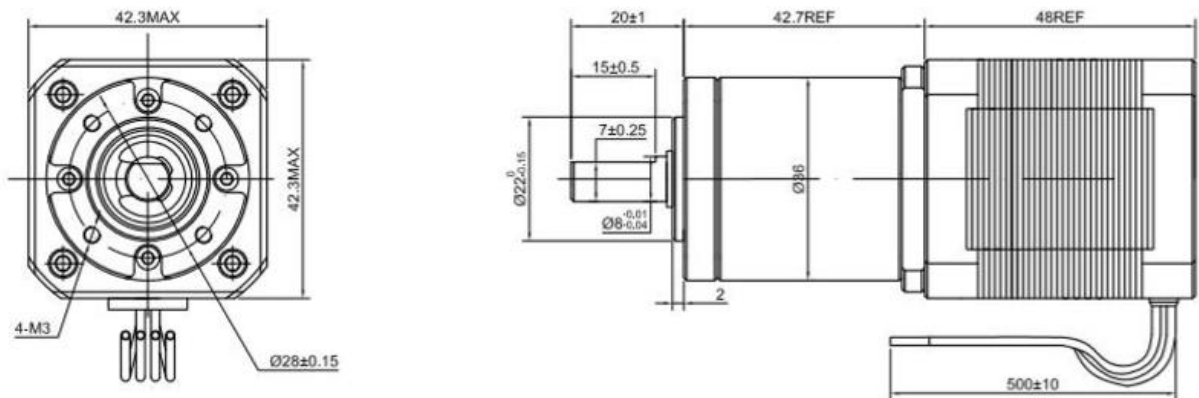

CABLAGGIO

CONNESSIONE		IL MOTORE
Numero di perno	Bipolare	Filo
1	A	Nero
2	A\	Verde
3	B	Rojo
4	B\	Blu

